

# ERGEBNISLISTE

## Norddeutsche Einzelmeisterschaft der U15m

Oldenburg/Holstein,

02.07.2023



-34kg	8 Teilnehmer		
<b>1. Platz</b>	Reif , Hendrik	Braunschweiger JC	NI
<b>2. Platz</b>	Rathmann , Jonathan	SFV Europa	NI
<b>3. Platz</b>	Wall, Klaas	TSV Lindewitt	SH
<b>3. Platz</b>	Shabanov, Amir	Bremen 1860	HB
5. Platz	Ehmann , David	TV Jahn Wolfsburg	NI
5. Platz	Plich , Samuel	VfL Grasdorf	NI
7. Platz	Kaiser, Lucian	Judo Club Tsukuri Weißenhäu	SH
7. Platz	Stefanski , Marvin	MTV Isenbüttel	NI
-37kg	11 Teilnehmer		
<b>1. Platz</b>	Sautiev, Mansur	Kano Bremerhaven	HB
<b>2. Platz</b>	Drews, Fabian	TSV Kronshagen	SH
<b>3. Platz</b>	Hohnsbein , Ben	Judoteam Hannover	NI
<b>3. Platz</b>	Borchashvili, Abu	Judo-Club Ahrensburg	SH
5. Platz	Atalan, Emanuel	Enjoy Judo	HB
5. Platz	Hayrapetyan, Gor	To-Judo-Kan Ratzeburg	SH
7. Platz	Schreiner , Leo Lo	Crocodiles Osnabrück	NI
7. Platz	Tyslenko , Nikita	Nordhorner Judo-Club	NI
-40kg	12 Teilnehmer		
<b>1. Platz</b>	Hromyk , Artem	VfL Grasdorf	NI
<b>2. Platz</b>	Wittenberg , Alessandro Damiano	VfL Grasdorf	NI
<b>3. Platz</b>	Hanson , Thure	MTV Geismar	NI
<b>3. Platz</b>	Evers, Fynn	PSV Eutin	SH
5. Platz	Achmadov, Ramsan	Bremen 1860	HB
5. Platz	Ertural, Emilian	PSV Eutin	SH
7. Platz	Ewers, Justin	T.H.Eilbeck	HH
7. Platz	Hayrapetyan, Gevorg	To-Judo-Kan Ratzeburg	SH
-43kg	15 Teilnehmer		
<b>1. Platz</b>	Wurm, Stephan	T.H.Eilbeck	HH
<b>2. Platz</b>	Schumann, Janek Paul	T.H.Eilbeck	HH
<b>3. Platz</b>	Hromyk , Dmytro	VfL Grasdorf	NI
<b>3. Platz</b>	Tansingco, Gabryl	Bramfelder SV	HH
5. Platz	König, Daniel	Octagon Sport	HB
5. Platz	Schophaus , Robert Luis	VfL Grasdorf	NI
7. Platz	Gluschenko, John	Villa Vital	HB
7. Platz	Arutunjans, Oleksander-ori	Budokan Lübeck	SH
-46kg	10 Teilnehmer		
<b>1. Platz</b>	Klishev, Yehor	T.H.Eilbeck	HH
<b>2. Platz</b>	Hoppe, Leon	To-Judo-Kan Ratzeburg	SH
<b>3. Platz</b>	Sinnhuber, Cristopher	Villa Vital	HB
<b>3. Platz</b>	Gehzai, Noah	Eimsbüttler TV	HH
5. Platz	Wirth, Roland	SASU	HB
5. Platz	Humbke, Silas	Ahrensböcker Judoclub	SH
7. Platz	Wittenberg, Lennard	Ahrensböcker Judoclub	SH
7. Platz	Kral , Mika	Judo Tiger Visbek	NI
-50kg	17 Teilnehmer		
<b>1. Platz</b>	Wiens, Daniel	JG Sachsenwald	HH
<b>2. Platz</b>	Mutoshvili , Muchammed	JC Göttingen im ASC	NI
<b>3. Platz</b>	Wagner, Arian	T.H.Eilbeck	HH
<b>3. Platz</b>	Shuster, Boris	Budokan Lübeck	SH
5. Platz	Ertural, Amael	PSV Eutin	SH
5. Platz	Kolke, Ramon	Villa Vital	HB
7. Platz	Yakhnin, Alexander	Eimsbüttler TV	HH
7. Platz	Garbade, Marlon	Villa Vital	HB

# ER G E B N I S L I S T E

## Norddeutsche Einzelmeisterschaft der U15m

Oldenburg/Holstein,

02.07.2023



-34kg	8 Teilnehmer		
-55kg	15 Teilnehmer		
<b>1. Platz</b>	Achmadov, Rasul	Bremen 1860	HB
<b>2. Platz</b>	Sonnemann , Jarne	Braunschweiger JC	NI
<b>3. Platz</b>	Spies, Leon	SV Giekau	SH
<b>3. Platz</b>	Dzhemaldinov, Ishan	Kano Bremerhaven	HB
5. Platz	Kulsha , Artur	Judoteam Hannover	NI
5. Platz	Paulus , Jan Gero	VfL Grasdorf	NI
7. Platz	Graf, Louis	T.H.Eilbeck	HH
7. Platz	Sautiev, Adam	Kano Bremerhaven	HB
-60kg	13 Teilnehmer		
<b>1. Platz</b>	Petirov, Amir	Kano Bremerhaven	HB
<b>2. Platz</b>	Chahin, Lucas	SCALA	HH
<b>3. Platz</b>	Tsoroev, Amin	Kano Bremerhaven	HB
<b>3. Platz</b>	Freier, Dan	Villa Vital	HB
5. Platz	Yarosh, Alexander	SC Tenri Bad Segeberg	SH
5. Platz	Voytenko, Maxim	SCALA	HH
7. Platz	Kidmann, Lyon	TuRa Harksheide	HH
7. Platz	Rösgen , Julius Ole	PSV Hannover	NI
-66kg	14 Teilnehmer		
<b>1. Platz</b>	Fenski, Ole	Budokan Lübeck	SH
<b>2. Platz</b>	Schnoing , Tammo	SV Eintracht Wiefelstede	NI
<b>3. Platz</b>	Ahrens, Jan Alexander	Villa Vital	HB
<b>3. Platz</b>	Ntoukam Kedem, Anriel	T.H.Eilbeck	HH
5. Platz	Mawlawi , Marwin	SFV Europa	NI
5. Platz	Grechnykh, Alexander	Budokan Lübeck	SH
7. Platz	Reichberg, Alfred	Tokaido Kappeln	SH
7. Platz	Sukhina , Mykhailo	TuS Rotenburg	NI
+66kg	13 Teilnehmer		
<b>1. Platz</b>	Erlich, Roland	Budokan Lübeck	SH
<b>2. Platz</b>	Pohurskyy , Jan	Crocodiles Osnabrück	NI
<b>3. Platz</b>	Hering, Alexander	TSJC Eutin	SH
<b>3. Platz</b>	Uhlig, Leif	TSG Concordia Schönkirchen	SH
5. Platz	Veselov, Lukas	TSV Kropp	SH
5. Platz	Bott , Maximilian	JKG Diekholzen	NI
7. Platz	Rauch , Maris	Judo Tiger Visbek	NI
7. Platz	Almanfi, Hadi	SV Eidelstedt	HH

# Hauptrunde

WIEGEZEIT:

Beginn: : Uhr  
 Ende: : Uhr

**U15m**

**-34kg**



**DJB**

Norddeutsche  
 Einzelmeisterschaft

Oldenburg/Holstein, 02.07.2023

(1)

8 Teilnehmer

1	Ehmann , David TV Jahn Wolfsburg	1
9		
5	Rathmann , Jonathan SFV Europa	2
13		
3	Plich , Samuel VfL Grasdorf	3
11	Shabanov, Amir Bremen 1860	3
7		
15	Kaiser, Lucian Judo Club Tsukuri Weißenhäuser	4
2		
10	Stefanski , Marvin MTV Isenbüttel	5
6		
14	Wall, Klaas TSV Lindewitt	6
4		
12		
8	Reif , Hendrik Braunschweiger JC	8
16		

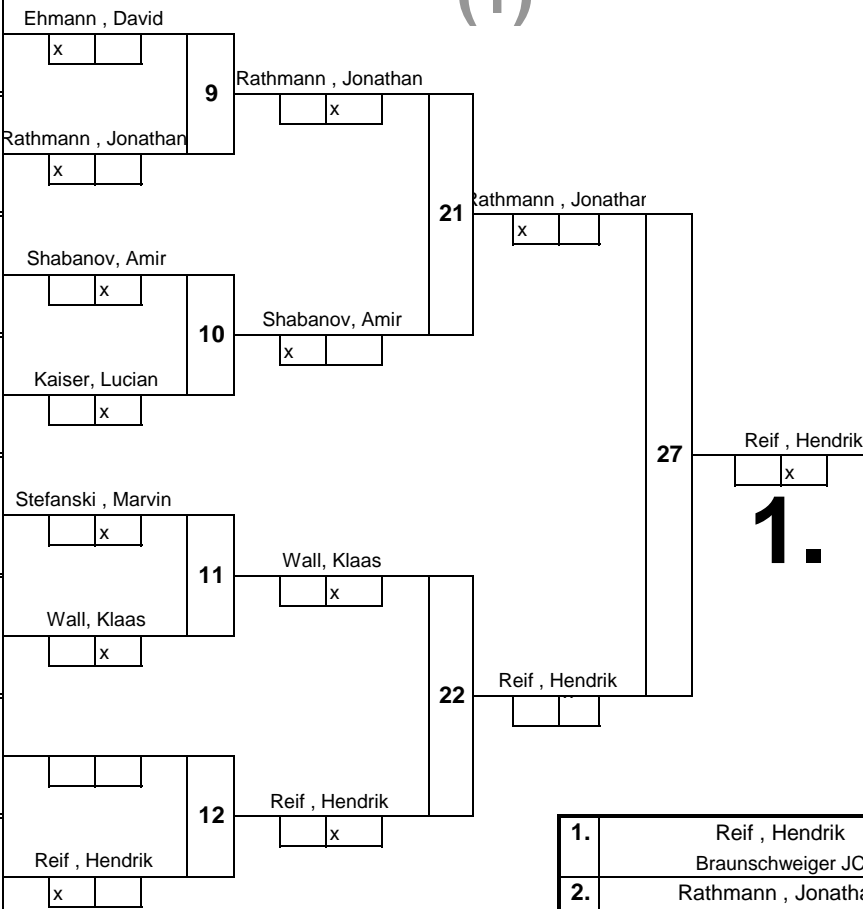

1.	Reif , Hendrik Braunschweiger JC
2.	Rathmann , Jonathan SFV Europa
3.	Wall , Klaas TSV Lindewitt
3.	Shabanov , Amir Bremen 1860
5.	Ehmann , David
5.	Plich , Samuel
7.	Kaiser , Lucian
7.	Stefanski , Marvin

5		
6		
7		
8		
1		
2		
3	Plich , Samuel	
4		

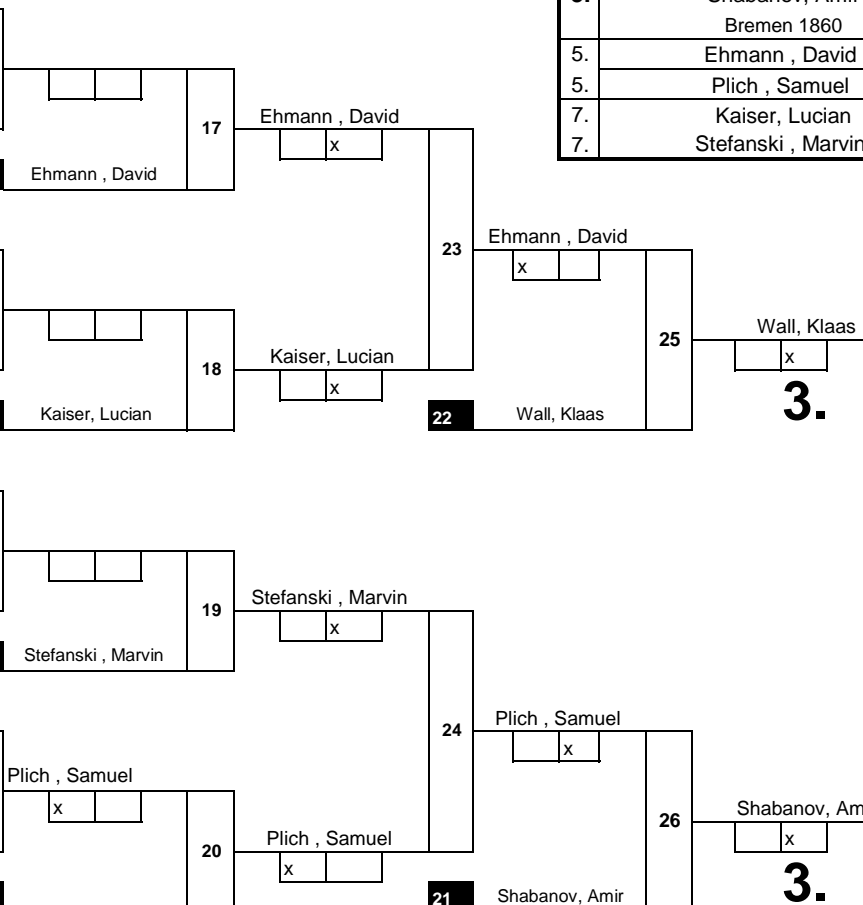

# Hauptrunde

ZEIT:

beginn: : Uhr  
 ende: : Uhr

(2)

11 Teilnehmer

1	Drews, Fabian TSV Kronshagen	1
9		
5	Atalan, Emanuel Enjoy Judo	2
13		
3		
11	Hißnauer, Max Rellinger TV	3
7	Borchashvili, Abu Judo-Club Ahrensburg	4
15	Tyslenko, Nikita Nordhomer Judo-Club	4
2	Hayrapetyan, Gor To-Judo-Kan Ratzeburg	5
10		
6		
14	Hohnsbein, Ben Judoteam Hannover	6
4	Schreiner, Leo Lo Crocodiles Osnabrück	7
12	Linn, Fabian JG Sachsenwald	7
8	Sautiev, Mansur Kano Bremerhaven	8
16	Thimsen, Simon TSV Lindewitt	8

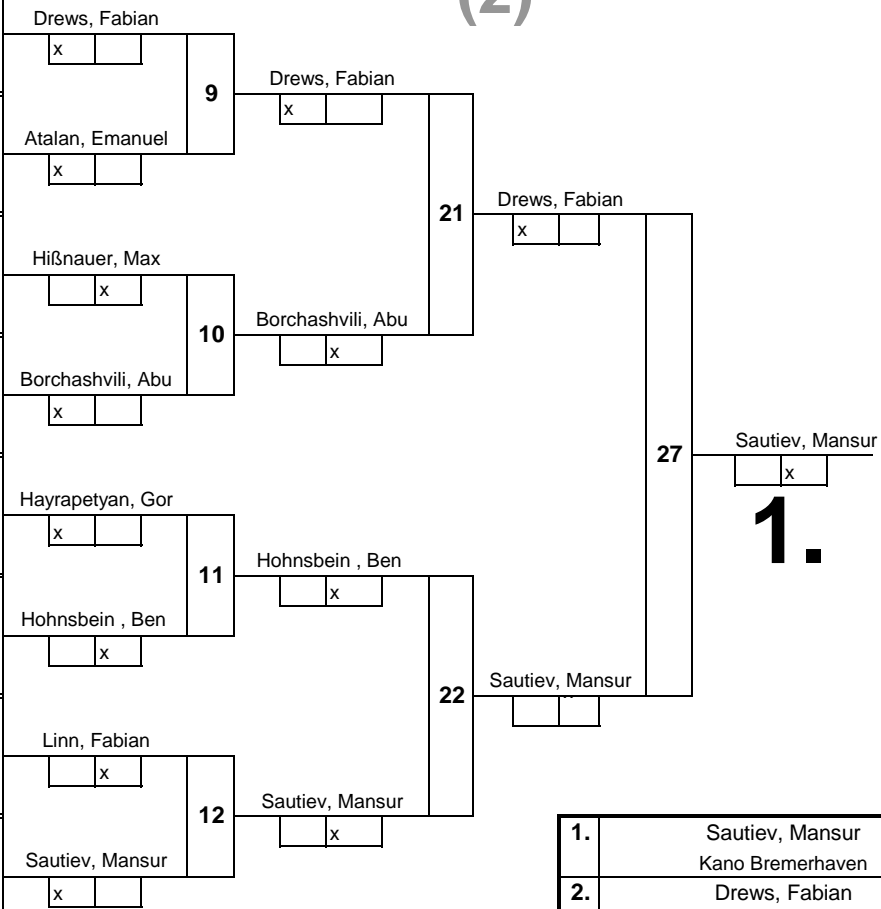

1.	Sautiev, Mansur Kano Bremerhaven
2.	Drews, Fabian TSV Kronshagen
3.	Hohnsbein, Ben Judoteam Hannover
3.	Borchashvili, Abu Judo-Club Ahrensburg
5.	Atalan, Emanuel
5.	Hayrapetyan, Gor
7.	Schreiner, Leo Lo
7.	Tyslenko, Nikita

5		
		13
6		
		17
	Atalan, Emanuel	9
7	Schreiner, Leo Lo	
		14
8	Thimsen, Simon	
		18
	Hißnauer, Max	10

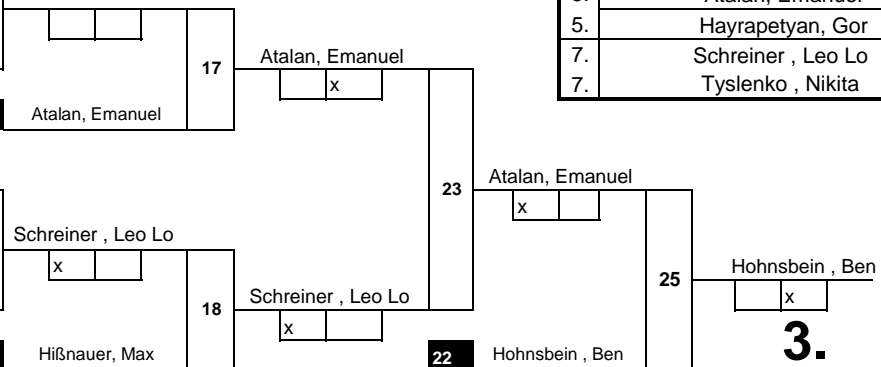

1		
		15
2		
		19
	Hayrapetyan, Gor	11
3		
		16
4	Tyslenko, Nikita	
		20
	Linn, Fabian	12

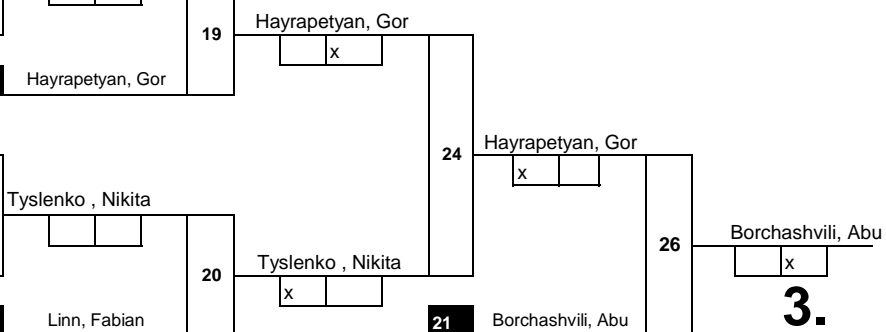

# Hauptrunde

WIEGEZEIT:

Beginn: : Uhr

Ende: : Uhr

**U15m**

**-40kg**



**DJB**

Norddeutsche Einzelmeisterschaft

Oldenburg/Holstein, 02.07.2023

(3)

12 Teilnehmer

1	Hromyk , Artem VfL Grasdorf	1	Hromyk , Artem						
17			x						
9					17	Hromyk , Artem			
25		2				x			
5	Krogull, Lars Harburger TB	3	Krogull, Lars					33	Hromyk , Artem
21			x						x
13	Hayrapetyan, Gevorg To-Judo-Kan Ratzeburg	4	Hayrapetyan, Gevorg		18	Hayrapetyan, Gevorg			
29			x			x			
3									49
19		5							x
11	Ertural, Emilian PSV Eutin	6	Ertural, Emilian		19	Ertural, Emilian			
27			x			x			
	Hanson , Thure MTV Geismar	7	Hanson , Thure					34	Hanson , Thure
23			x						
15	Tashtamirov, Said Kano Bremerhaven	8	Tashtamirov, Said		20	Hanson , Thure			
31			x			x			HSM
2	Wittenberg , Alessandro Da VfL Grasdorf	9	Wittenberg , Alessandro Da						
18			x						59
10	Busse, Maximilian TuRa Harksheide	10	Busse, Maximilian		21	Wittenberg , Alessandro Da			
26			x			x			
6									
22		11							
14	Achmadov, Ramsan Bremen 1860	12	Achmadov, Ramsan		22	Achmadov, Ramsan			
30			x			x			
4	Becker, Vadim Enjoy Judo	13	Becker, Vadim						
20			x						
12	Evers, Fynn PSV Eutin	14	Evers, Fynn		23	Evers, Fynn			
28			x			x			
	Ewers, Justin T.H.Eilbeck	15	Ewers, Justin						
24			x						
16		16			24	Ewers, Justin			
32						x			

**1.**

# Trostrunde

(3)

1.	Hromyk , Artem VfL Grasdorf
2.	Wittenberg , Alessandro Damiano VfL Grasdorf
3.	Hanson , Thure MTV Geismar
3.	Evers, Fynn PSV Eutin
5.	Achmadov, Ramsan
5.	Ertural, Emilian
7.	Ewers, Justin Hayrapetyan, Gevorg

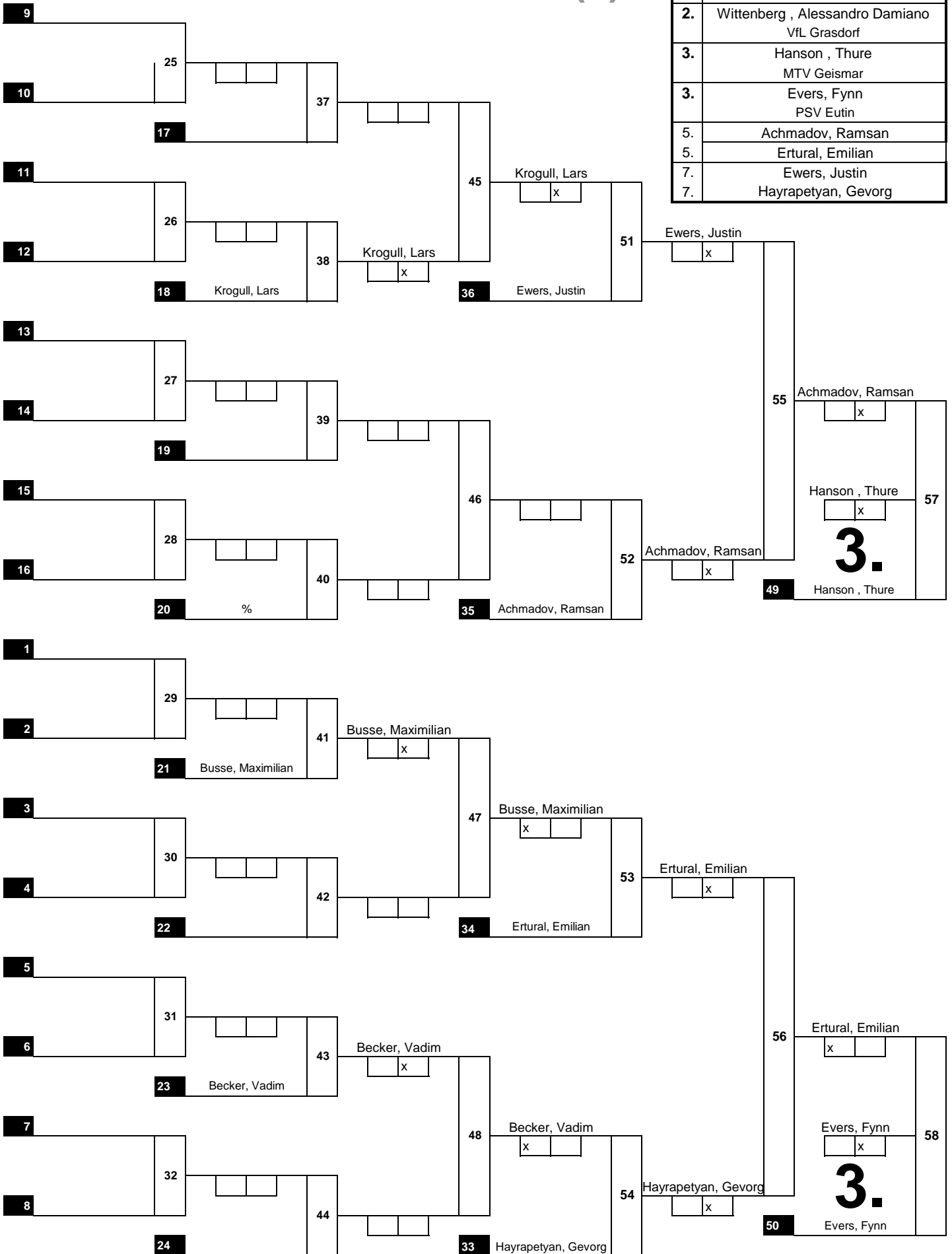

# Hauptrunde

BEZEIT: \_\_\_\_\_  
 Beginn: \_\_\_\_\_ Uhr  
 Ende: \_\_\_\_\_ Uhr

(4)

15 Teilnehmer

1	Wurm, Stephan T.H.Eilbeck	1
9		
5	Gluschenko, John Villa Vital	2
13	Jacobsen, Marten TSV Kronshagen	
3	Zimmermann, Felix TSV Bassum	3
11	Arutunjans, Oleksander-ori Budokan Lübeck	
7	Noetzel, Linus JG Sachsenwald	4
15	Schophaus , Robert Luis VfL Grasdorf	
2	Tansingco, Gabryl Bramfelder SV	5
10	Matrusiew, Amir Enjoy Judo	
6	Mirzakanov, Adam Judo-Club Ahrensburg	6
14	Hromyk , Dmytro VfL Grasdorf	
4	Johannes , Tom Judo Tiger Visbek	7
12	Kadirov, Magomed Budokan Lübeck	
8	König, Daniel Octagon Sport	8
16	Schumann, Janek Paul T.H.Eilbeck	

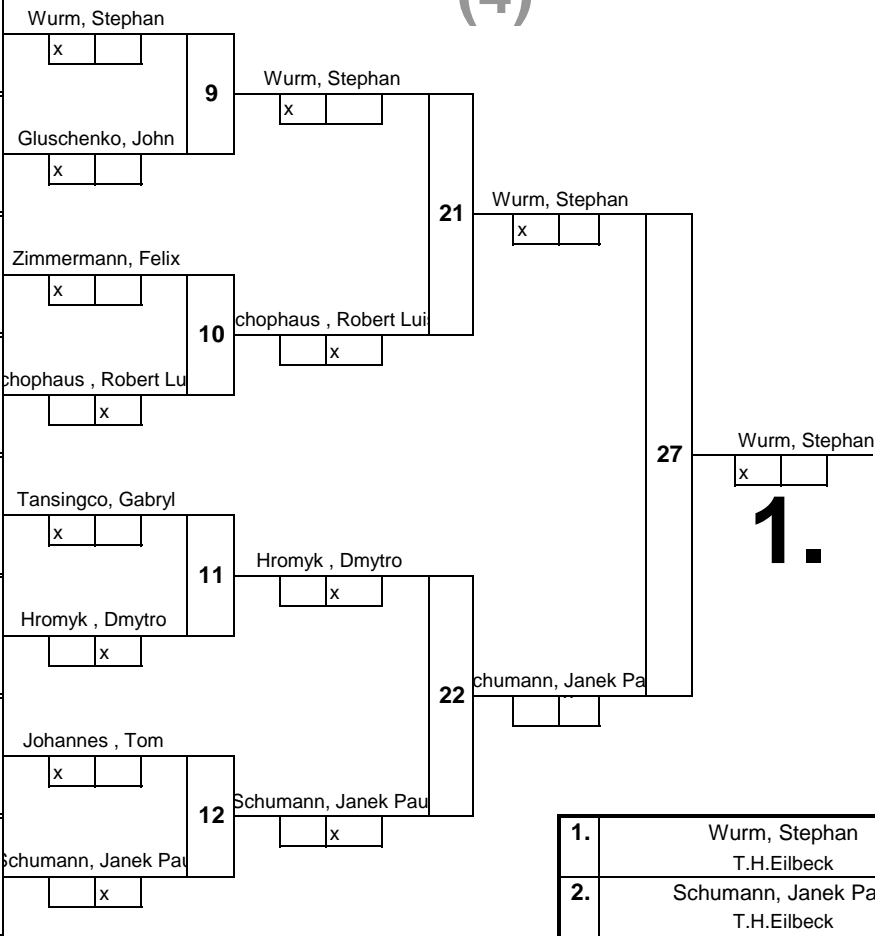

1.	Wurm, Stephan T.H.Eilbeck
2.	Schumann, Janek Paul T.H.Eilbeck
3.	Hromyk , Dmytro VfL Grasdorf
3.	Tansingco, Gabryl Bramfelder SV
5.	König, Daniel
5.	Schophaus , Robert Luis
7.	Gluschenko, John
7.	Arutunjans, Oleksander-ori

5	Matrusiew, Amir	
13	Mirzakanov, Adam	
6	Mirzakanov, Adam	13
9	Gluschenko, John	
17	Gluschenko, John	
7	Kadirov, Magomed	
14	König, Daniel	
8	König, Daniel	14
10	Zimmermann, Felix	
18	König, Daniel	
23	König, Daniel	
1		
15	Jacobsen, Marten	
2	Jacobsen, Marten	15
11	Tansingco, Gabryl	
19	Tansingco, Gabryl	
3	Arutunjans, Oleksander-ori	
16	Arutunjans, Oleksander-ori	
4	Noetzel, Linus	16
12	Johannes , Tom	
20	Arutunjans, Oleksander-ori	
21	Schophaus , Robert Luis	
24	Tansingco, Gabryl	
26	Tansingco, Gabryl	

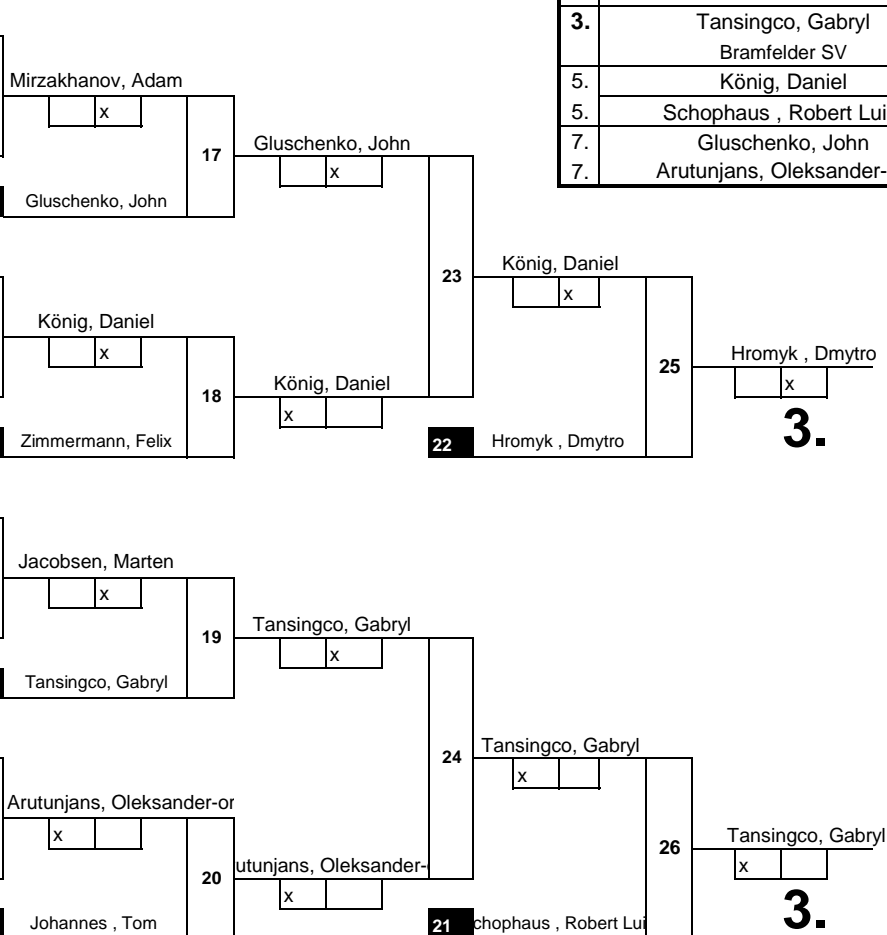

3.

3.





# Hauptrunde

WIEGEZEIT:

Beginn: : Uhr

Ende: : Uhr

**U15m**

**-50kg**



**DJB**

Norddeutsche Einzelmeisterschaft

Oldenburg/Holstein, 02.07.2023

(6)

17 Teilnehmer

1	Mutoshvili , Muchammed JC Göttingen im ASC	1	Mutoshvili , Muchammed						
17			x						
9	Gerdts, Victor JG Sachsenwald	2	Yakhnin, Alexander	17	Mutoshvili , Muchammed				
25	Yakhnin, Alexander Eimsbüttler TV		x						
5	Gland, Thorge To-Judo-Kan Ratzeburg	3	Gland, Thorge						
21			x						
13	Garbade, Marlon Villa Vital	4	Garbade, Marlon	18	Garbade, Marlon				
29			x						
3	Thiel, Moritz Budokan Lübeck	5	Thiel, Moritz						
19			x						
11	Kolke, Ramon Villa Vital	6	Kolke, Ramon	19	Kolke, Ramon				
27			x						
	Zeller , Fabian SV Nienhagen	7	Zeller , Fabian						
23			x						
15	Wagner, Arian T.H.Eilbeck	8	Wagner, Arian	20	Wagner, Arian				
31			x						
2	Riepin , Ernest Braunschweiger JC	9	Riepin , Ernest						
18			x						
10	Ertural, Amael PSV Eutin	10	Ertural, Amael	21	Ertural, Amael				
26			x						
6		11							
22									
14	Wiens, Daniel JG Sachsenwald	12	Wiens, Daniel	22	Wiens, Daniel				
30			x						
4	Schmidt, Nilas Thore VFL Pinneberg	13	Elsin, Daniil						
20	Elsin, Daniil SCALA		x						
12	Tjart, Felix Bremen 1860	14	Tjart, Felix	23	Tjart, Felix				
28			x						
	Shuster, Boris Budokan Lübeck	15	Shuster, Boris						
24			x						
16	Wichmann , Thorge JC Godshorn	16	Wichmann , Thorge	24	Shuster, Boris				
32			x						

33	Mutoshvili , Muchammed		x						
49	Mutoshvili , Muchammed		x						
34	Wagner, Arian								
59	Wiens, Daniel		x						
35	Wiens, Daniel		x						
50	Wiens, Daniel		x						
36	Shuster, Boris								
			x						

**1.**

# Trostrunde

(6)

1.	Wiens, Daniel JG Sachsenwald
2.	Mutoshvili , Muchammed JC Göttingen im ASC
3.	Wagner, Arian T.H.Eilbeck
3.	Shuster, Boris Budokan Lübeck
5.	Ertural, Amael
5.	Kolke, Ramon
7.	Yakhnin, Alexander
7.	Garbade, Marlon

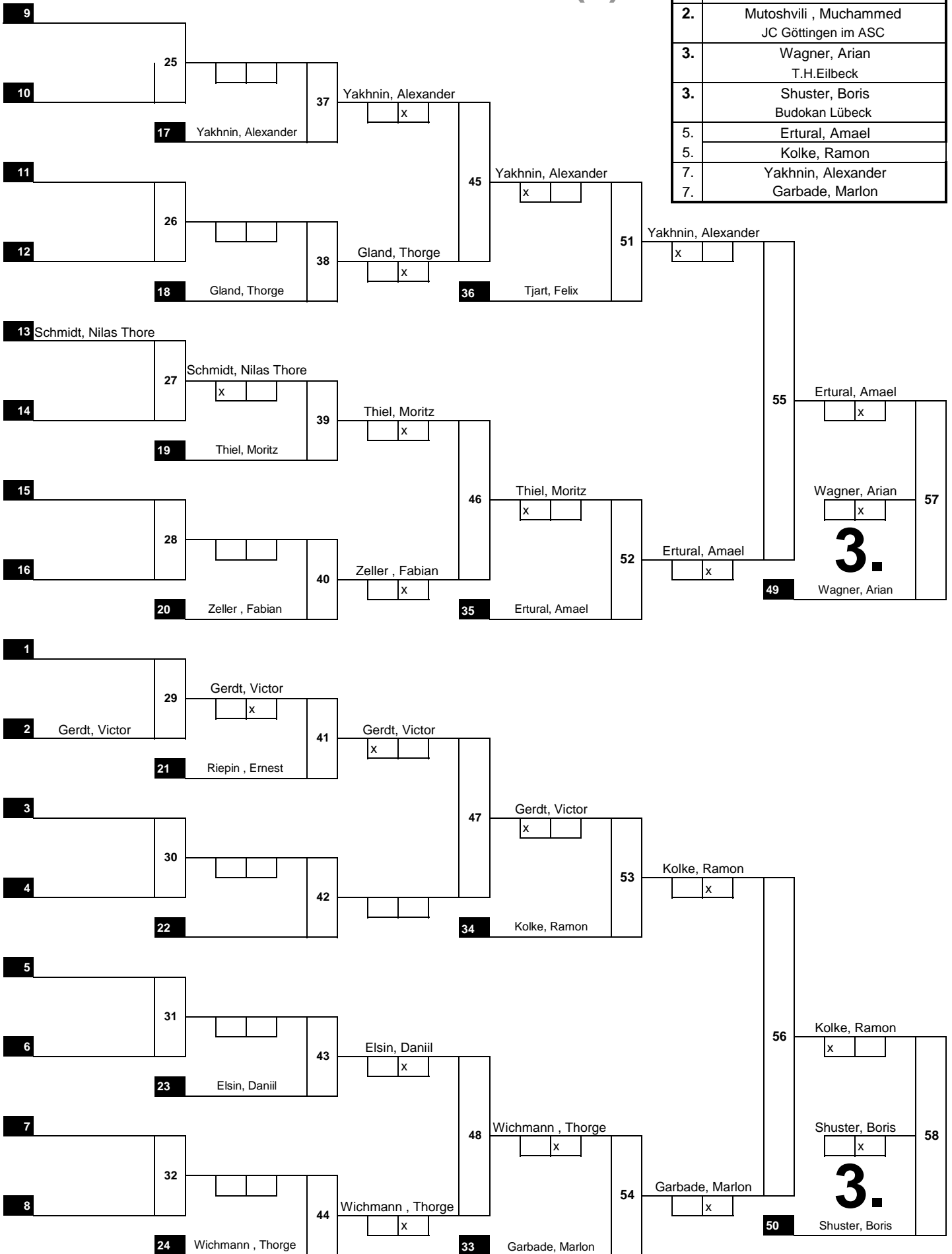

# Hauptrunde

WIEGEZEIT:

Beginn: : Uhr

Ende: : Uhr

U15m

-55kg



DJB

Norddeutsche Einzelmeisterschaft

Oldenburg/Holstein, 02.07.2023

(7)

15 Teilnehmer

1	Sonnemann , Jarne Braunschweiger JC	1	Sonnemann , Jarne						
17			x						
9	Düring, Moritz Budokan Lübeck	2	Düring, Moritz	17	Sonnemann , Jarne				
25	Eggemann, Nick TSV Kropp		x						
5	Dzhemaldinov, Ishan Kano Bremerhaven	3	Dzhemaldinov, Ishan						
21			x						
13	Rohweder, Ben Bramfelder SV	4	Rohweder, Ben	18	Dzhemaldinov, Ishan				
29			x						
3		5							
19									
11	Noebel, Levi Judoklub Elmshorn	6	Noebel, Levi	19	Noebel, Levi				
27			x						
	Kulsha , Artur Judoteam Hannover	7	Kulsha , Artur						
23			x						
15	Iskam, Gabriel TSV Kronshagen	8	Iskam, Gabriel	20	Kulsha , Artur				
31			x						
2	Paulus , Jan Gero VfL Grasdorf	9	Paulus , Jan Gero						
18			x						
10	Sautiev, Adam Kano Bremerhaven	10	Sautiev, Adam	21	Paulus , Jan Gero				
26			x						
6		11							
22									
14	Spies, Leon SV Giekau	12	Spies, Leon	22	Spies, Leon				
30			x						
4	Kovalev, Israil PSV Eutin	13	Kovalev, Israil						
20			x						
12	Graf, Louis T.H.Eilbeck	14	Graf, Louis	23	Graf, Louis				
28			x						
	Achmadov, Rasul Bremen 1860	15	Achmadov, Rasul						
24			x						
16	Kuscholke , Elias Crocodiles Osnabrück	16	Kuscholke , Elias	24	Achmadov, Rasul				
32			x						

33	Sonnemann , Jarne		x						
49	Sonnemann , Jarne		x						
34	Kulsha , Artur								
59	Achmadov, Rasul		x						
35	Paulus , Jan Gero		x						
50	Achmadov, Rasul								
36	Achmadov, Rasul								

1.

# Trostrunde

(7)

1.	Achmadov, Rasul Bremen 1860
2.	Sonnemann, Jarne Braunschweiger JC
3.	Spies, Leon SV Giekau
3.	Dzhemaldinov, Ishan Kano Bremerhaven
5.	Kulsha, Artur
5.	Paulus, Jan Gero
7.	Graf, Louis
7.	Sautiev, Adam

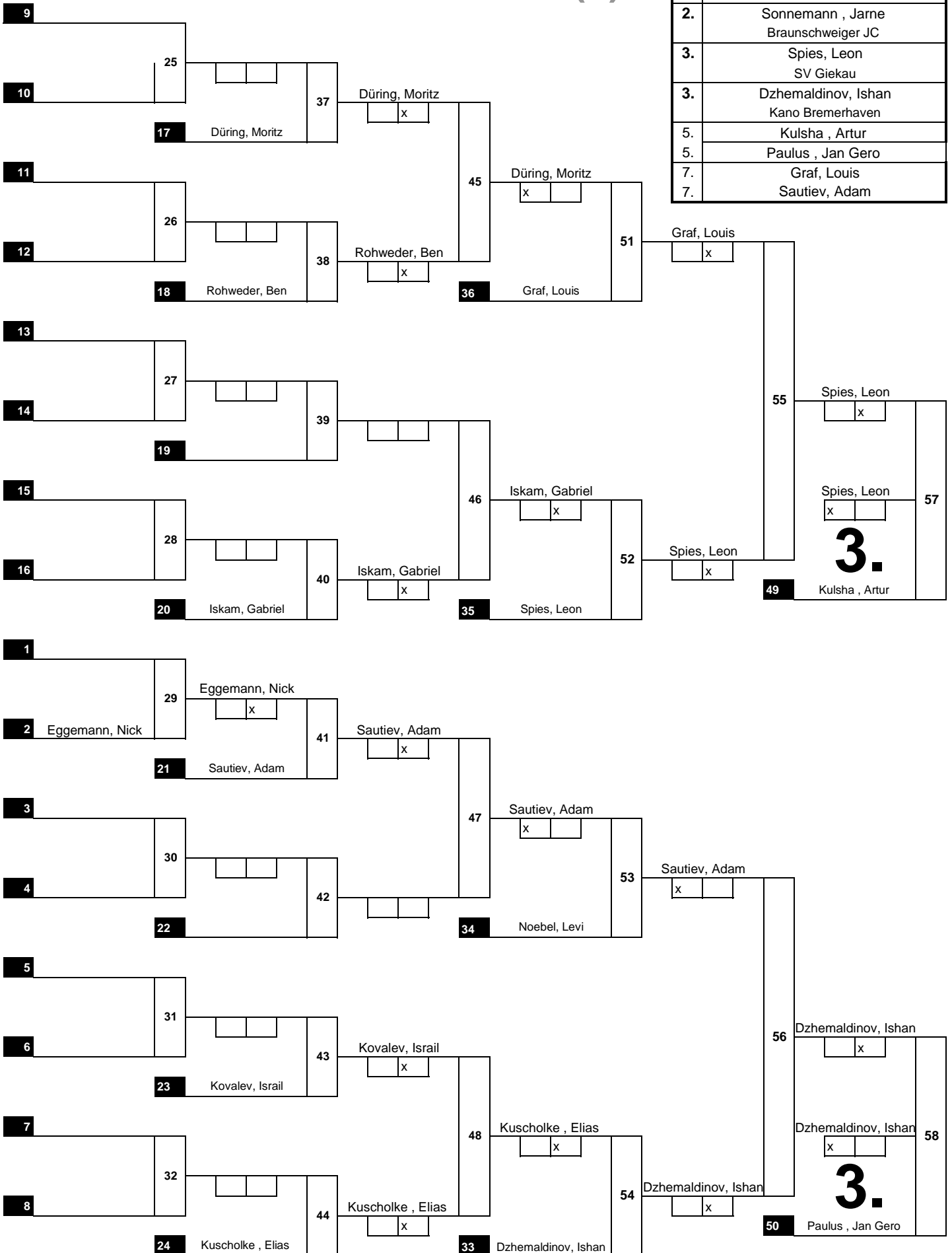

# Hauptrunde

WIEGEZEIT:

Beginn: : Uhr  
 Ende: : Uhr

U15m

-60kg



Norddeutsche Einzelmeisterschaft  
 Oldenburg/Holstein, 02.07.2023

(8)

13 Teilnehmer

1	Yarosh, Alexander SC Tenri Bad Segeberg	1
9	Voytenko, Maxim SCALA	
5	Bosma, Mick Judo Tiger Visbek	2
13	Petrov, Amir Kano Bremerhaven	
3		
11	Freier, Dan Villa Vital	3
7	Avcilar, Dean TSV Nahe	4
15	Kidmann, Lyon TuRa Harksheide	
2	Weinberger, Leopold Kuzushi Bad Schwartau	5
10		
6		
14	Chahin, Lucas SCALA	6
4	Popper, Jannis Eimsbüttler TV	7
12	Tsoroev, Amin Kano Bremerhaven	
8	Rösgen, Julius Ole PSV Hannover	8
16	Frahm, Hubertus Judo Club Tsukuri Weißenhäuser	

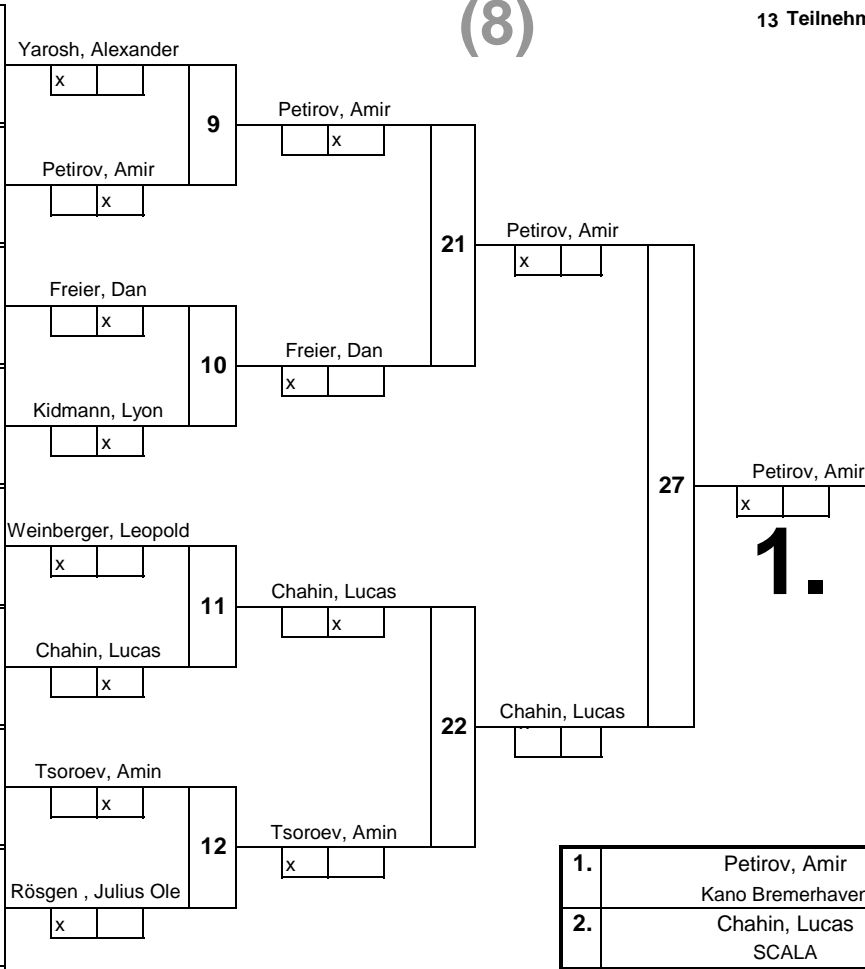

1.	Petrov, Amir Kano Bremerhaven
2.	Chahin, Lucas SCALA
3.	Tsoroev, Amin Kano Bremerhaven
3.	Freier, Dan Villa Vital
5.	Yarosh, Alexander
5.	Voytenko, Maxim
7.	Kidmann, Lyon
7.	Rösgen, Julius Ole

5		
6		13
7	Popper, Jannis	
8	Frahm, Hubertus	14
1	Voytenko, Maxim	
2	Bosma, Mick	15
3		
4	Avcilar, Dean	16

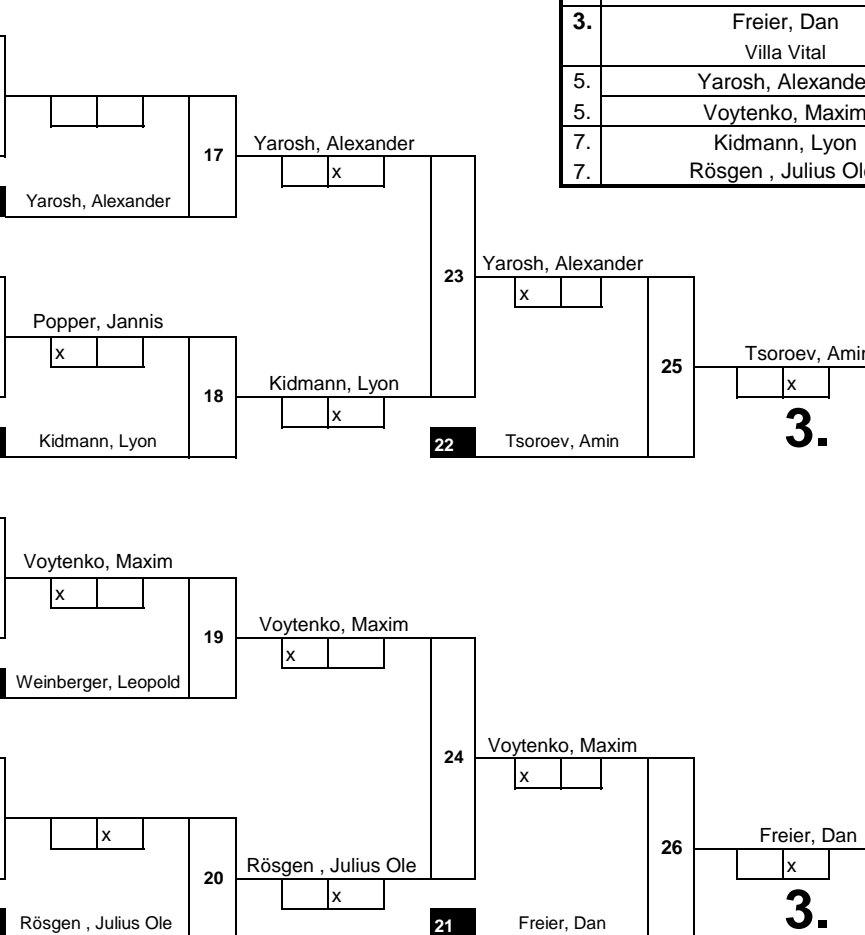

3.

3.

# Hauptrunde

WIEGEZEIT:

Beginn: : Uhr

Ende: : Uhr

**U15m**

**-66kg**



**DJB**

Norddeutsche Einzelmeisterschaft  
Oldenburg/Holstein, 02.07.2023

(9)

14 Teilnehmer

1	Kahrimani, Ensar SCALA	1	Kahrimani, Ensar						
17			x						
9	Kilian, David Judo Club Tsukuri Weißenhäuse	2	Kilian, David	17	Kahrimani, Ensar				
25			x		x				
5	Schnoing, Tammo SV Eintracht Wiefelstede	3	Schnoing, Tammo						
21			x						
13		4							
29									
3	Mawlawi, Marwin SFV Europa	5	Mawlawi, Marwin						
19			x						
11	Ahrens, Jan Alexander Villa Vital	6	Ahrens, Jan Alexander	19	Ahrens, Jan Alexander				
27			x		x				
	Cetrinözman, Ata T.H.Eilbeck	7	Cetrinözman, Ata						
23			x						
15	Grechnykh, Alexander Budokan Lübeck	8	Grechnykh, Alexander						
31			x						
2	Lyagin, Michail Bramfelder SV	9	Lyagin, Michail						
18			x						
10	Lammert, Elias MTV Isenbüttel	10	Lammert, Elias	21	Lyagin, Michail				
26			x		x				
6		11							
22									
14	Fenski, Ole Budokan Lübeck	12	Fenski, Ole	22	Fenski, Ole				
30			x		x				
4	Reichberg, Alfred Tokaido Kappeln	13	Reichberg, Alfred						
20			x						
12		14							
28									
	Sukhina, Mykhailo TuS Rotenburg	15	Sukhina, Mykhailo						
24			x						
16	Ntoukam Kedem, Anriel T.H.Eilbeck	16	Ntoukam Kedem, Anriel	24	Ntoukam Kedem, Anriel				
32	Bartels, Sam Oliver VFL Pinneberg		x		x				

17	Kahrimani, Ensar	33	Schnoing, Tammo	49	Schnoing, Tammo
33	Schnoing, Tammo	49	Schnoing, Tammo	59	Fenski, Ole
49	Schnoing, Tammo	59	Fenski, Ole	59	Fenski, Ole
59	Fenski, Ole	59	Fenski, Ole	59	Fenski, Ole

**1.**

# Trostrunde



(9)

1.	Fenski, Ole Budokan Lübeck
2.	Schnoing, Tammo SV Eintracht Wiefelstede
3.	Ahrens, Jan Alexander Villa Vital
3.	Ntoukam Kedem, Anriel T.H.Eilbeck
5.	Mawlawi, Marwin
5.	Grechnykh, Alexander
7.	Reichberg, Alfred
7.	Sukhina, Mykhailo

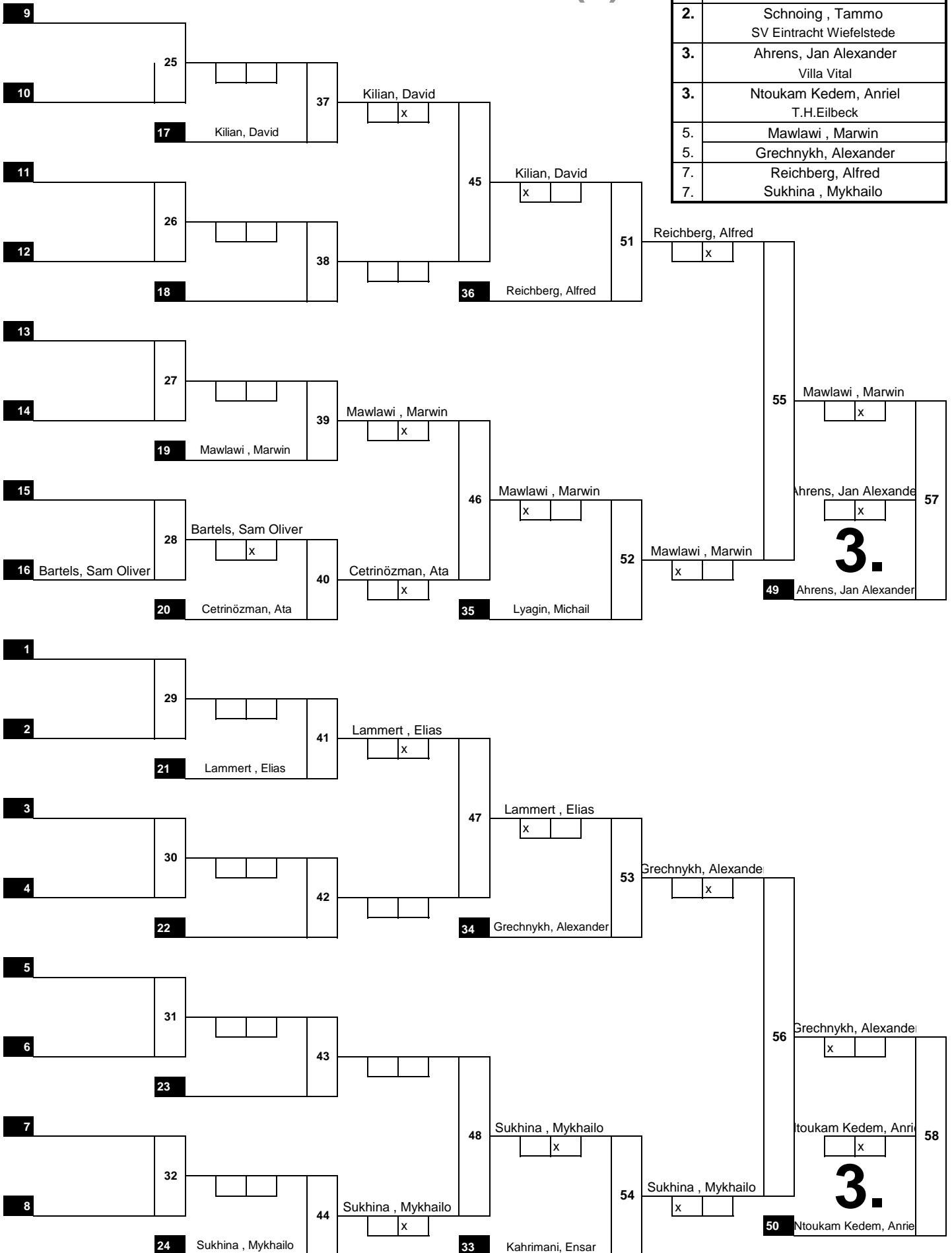

# Hauptrunde

WIEGEZEIT:

Beginn: : Uhr

Ende: : Uhr

**U15m +66kg DJB** Norddeutsche Einzelmeisterschaft  
Oldenburg/Holstein, 02.07.2023

(10)

13 Teilnehmer

1	Hering, Alexander TSJC Eutin	1	Hering, Alexander				
17			x				
9					17	Hering, Alexander	
25		2				x	
5							33
21		3					
13	Nieters, Robert Crocodiles Osnabrück	4	Nieters, Robert		18	Nieters, Robert	
29			x				
3							49
19		5					
11	Pohurskyy, Jan Crocodiles Osnabrück	6	Pohurskyy, Jan		19	Pohurskyy, Jan	
27			x				
	Uhlig, Leif TSG Concordia Schönkirchen	7	Uhlig, Leif				34
23			x				
15	Drescher, Henry JC Taiyo	8	Drescher, Henry		20	Uhlig, Leif	
31			x			x	
2	Veselov, Lukas TSV Kropp	9	Veselov, Lukas				59
18			x				
10					21	Veselov, Lukas	
26		10				x	
6	Rauch, Maris Judo Tiger Visbek	11	Bott, Maximilian				35
22	Bott, Maximilian JKG Diekholzen			x			
14	Comic, Armin T.H.Eilbeck	12	Comic, Armin		22	Bott, Maximilian	
30			x			x	
4	Almanfi, Hadi SV Eidelstedt	13	Almanfi, Hadi				50
20			x				
12	Sartison, Enrico Judo Tiger Visbek	14	Sartison, Enrico		23	Sartison, Enrico	
28			x				
							36
24		15					
16	Kleis, Nico SC Itzehoe	16	Erlich, Roland		24	Erlich, Roland	
32	Erlich, Roland Budokan Lübeck			x			

**1.**



# Trostrunde

(10)

1.	Erlich, Roland Budokan Lübeck
2.	Pohurskyy, Jan Crocodiles Osnabrück
3.	Hering, Alexander TSJC Eutin
3.	Uhlig, Leif TSG Concordia Schönkirchen
5.	Veselov, Lukas
5.	Bott, Maximilian
7.	Rauch, Maris
7.	Almanfi, Hadi

